



A Polyhydron Group Company

THROTTLE CUM CHECK VALVE MODULAR CONSTRUCTION

Model : TCM10

Ref. No. D 04546 A
Release 11 / 2020

ENGINEERING - 1 of 2

Description

Throttle check valves model **TCM 10** are meant for controlling flow in one direction in circuit by simple throttling of flow. Reverse flow is free and is independent of throttle condition in opposite direction in same path. The valve is available with throttle check valve facility on either A port, B port or A and B ports.

These are non-pressure compensated flow control valves and therefore offer constant flow for a given setting, only if the pressure drop across the throttled passage is constant.

The valve can be converted from meter-in condition to meter-out condition by simply rotating the body along its longitudinal axis by 180 degree, while being installed.

Rotation of the throttling screw in clockwise direction, increase the pressure drop in the path.

For locking the setting, a check nut is provided.

For protection of the setting, a protective cap is provided.

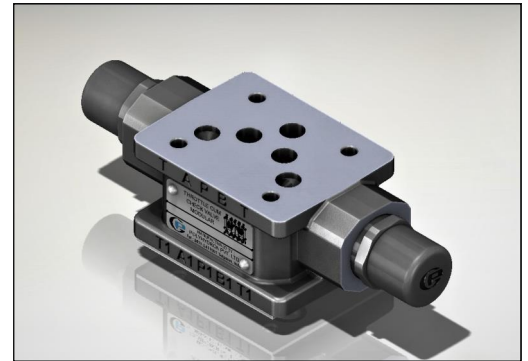

Section

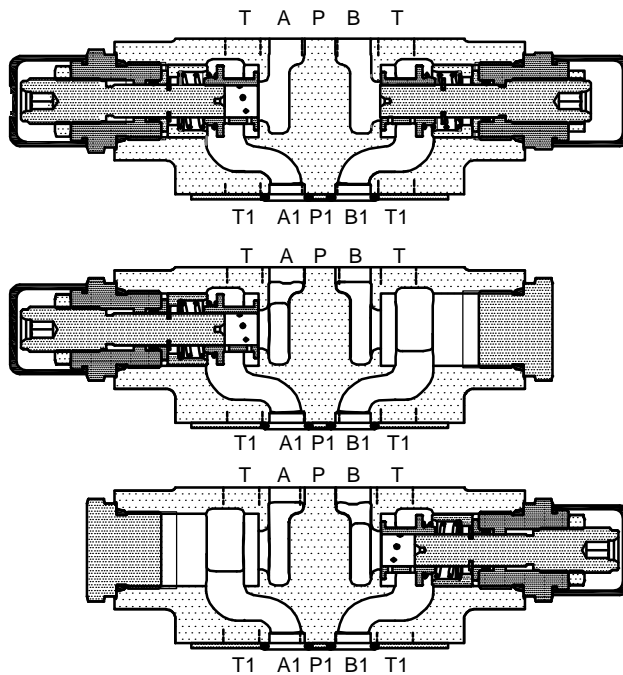

Hydraulic symbol

TCM 10 AB

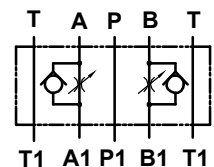

TCM 10 A

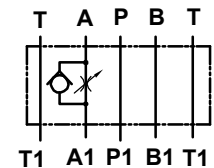

TCM 10 B

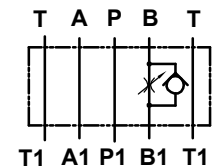

Technical specifications

Construction	:	Modular, spool type, Non-pressure compensated.	
Mounting	:	Modular type, Conforming to 4401 - 05 - 04 - 0 - 94.	
Mounting Position	:	Optional.	
Direction of flow	:	For ports P and T free flow in either direction. For ports A and B refer Hydraulic symbols.	
Nominal flow handling capacity	:	100 l/min.	
Operating Pressure	:	315 bar.	
Viscosity range	:	10 cSt to 380 cSt.	
Fluid temperature range	:	-10°C to +80°C.	
Fluid cleanliness required	:	ISO 4406 20/18/15 or better.	
Mass approx.	:	Model	TCM10AB
		in Kg.	2.1
		Model	TCM10A/B
		in Kg.	2

polyhydron pvt. ltd.

78-80, Machhe Industrial Estate,
Machhe, Belgaum - 590 014. INDIA.

Phone : +91-(0)831- 2411001
Fax : +91-(0)831- 2411002
E-mail : polyhydron@gmail.com
Website : www.polyhydron.com



Unit dimensions

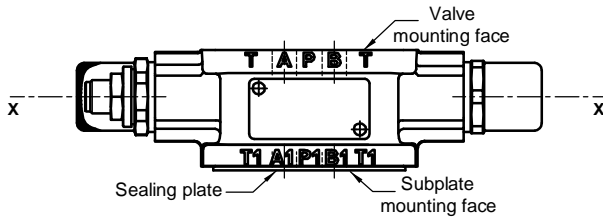

Flow control Screw (5 A/F)
Clock wise rotation causes decrease in oil flow.

Dimensions in mm.

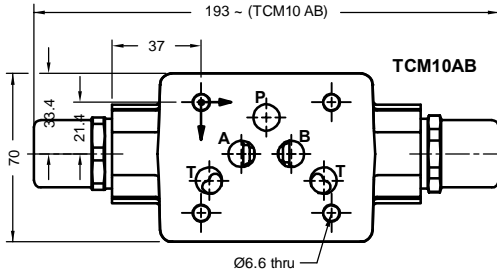
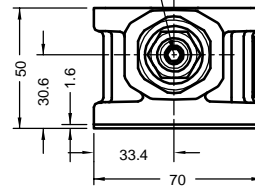
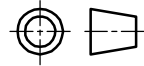

Subplate mounting interface as per ISO 4401.

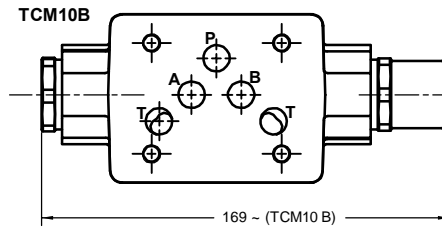
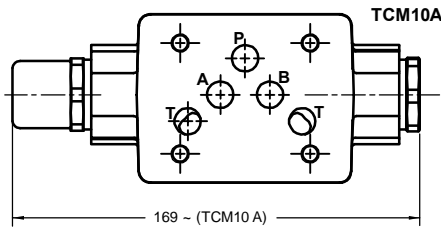
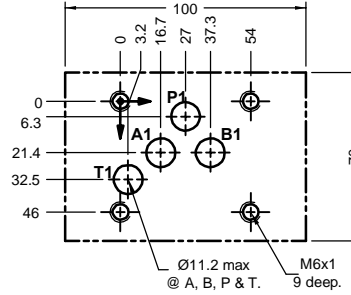

Note : Rotate the valve around horizontal axis 'X' - 'X' by 180° to convert from METER-IN control to METER-OUT control.
Valve fixing S.H.C Screws are not in scope of supply. Tightening torque for S.H.C Screws is 16 Nm.

Performance graph

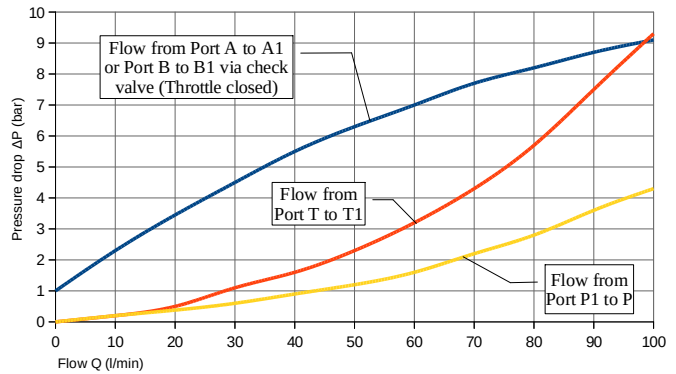
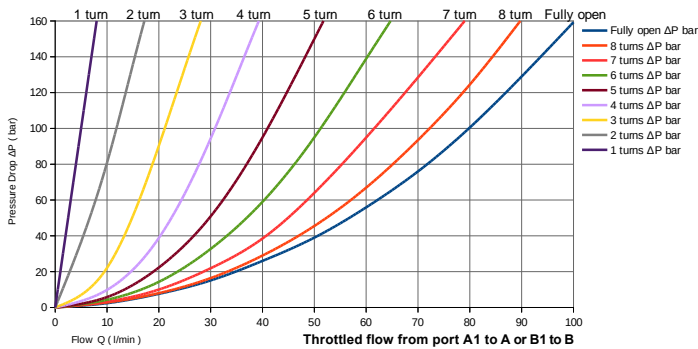

Ordering code

TCM 10 AB - 23

Throttle cum check valve modular construction

Size 10

Throttle / check facility	
On A & B ports	AB
On 'A' port only	A
On 'B' port only	B

Design code subjected to Change . installation dimensions remain same for design code 20 thru 29.

All rights reserved.
Subject to change without prior notice.
Due to continuous improvement in the design of the product, the actual product supplied may look different than shown above.
For critical applications, please ask for certified installation drawing.